

## GV-LPC2210 2MP 2.5x Zoom Super Low Lux Color Network Camera



- 1/2.8" progressive scan super low lux CMOS
- Motorized varifocal lens for remote focus / zoom adjustment
- Dual streams from MJPEG or H.264
- Up to 30 fps at 1920 x 1080
- Maximum speed 120 km/h (75 mph)
- Recognition for reflective License Plate only
- Vandal resistance (IK10 for metal casing)
- Ingress protection (IP67)
- Maximum IR distance 20 m (65.6 ft)
- DC 48V / AC 24V (optional) / PoE ++ (120 W)
- Built-in heater and fan
- Support for TV-out
- Two-way audio
- Support for I/O (1 in / 1 out)
- Defog
- Motion detection
- Privacy Mask
- Text overlay
- IP address filtering
- Supports iPhone, iPad, Android & 3GPP
- ONVIF (Profile S) conformant
- 31 languages on Web interface

\* Optional GV-PA482 PoE Adapter is required for applying PoE function.

### Introduction

GV-LPC2210 is a 2 MP color network camera designed for recognition of reflective license plates on vehicles traveling up at 120 km/h (75 mph) or less with extreme temperature resistance (-40°C ~ 50°C / -40°F ~ 122°F). It is weather proof (IP67). Equipped with a Super Low Lux CMOS image sensor, the camera is capable of displaying a color live view at near darkness. Its multiple high-power LEDs and build-in intelligent IR provide clear license plate for two lanes under low-light conditions at a maximum IR distance of 20 m (65.6 ft.). The motorized varifocal lens take the advantage of its motorized focus / zoom in that the user can remotely adjust the focus and zoom through the Web interface.

### Dimensions

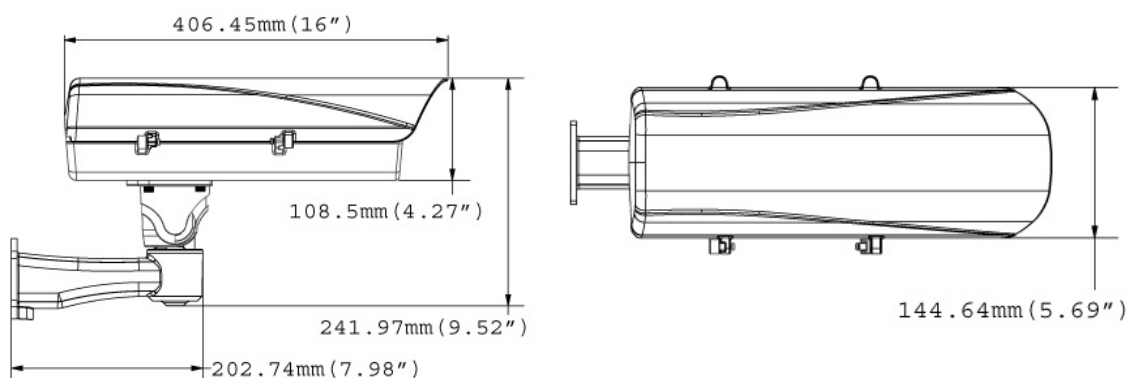

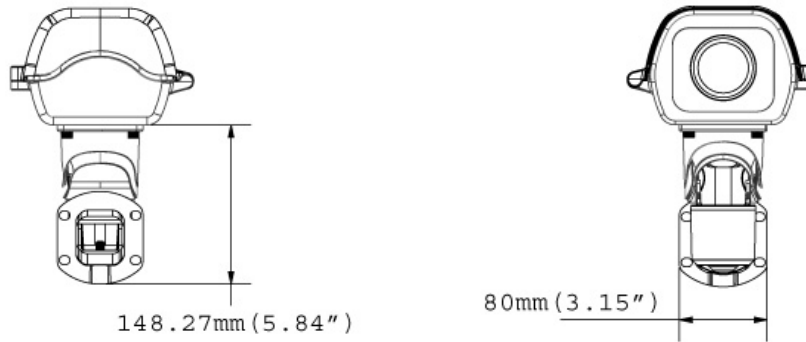

## Specifications

Camera		
Image Sensor	1/2.8" progressive scan super low lux CMOS	
Picture Elements	1920 (H) x 1080 (V)	
Camera Type	Color, B/W	
Shutter Speed	Auto / Manual (1/120 ~ 1/2000 sec)	
White Balance	Auto / Manual (2800K ~ 8500K)	
S/N Ratio	52 dB	
Max. Speed	120 km/h (75 mph)	
Lens		
Megapixel	2 MP	
Lens Type	Motorized varifocal lens	
Focal Length	9 ~ 22 mm	
Maximum Aperture	F/1.2	
Lens Mount	Ø14 mm	
Image Format	1/2.7"	
Horizontal FOV	38° ~ 18°	
Operation	Focus	Auto
	Zoom	2.5x optical zoom
	Iris	P-Iris
IR LED Quantity	4 high power IR LEDs	
IR Distance	10 ~ 20 m (32.8 ~ 65.6 ft)	
Operation		
Video Compression	H.264, MJPEG	
Video Stream	Dual streams from H.264 or MJPEG	
Frame Rate	30 fps at 1920 x 1080 (60/50 Hz) * The frame rate and the performance may vary depending on the number of connections and data bitrates (different scenes)	
Image Setting	Brightness, Contrast, Saturation, Sharpness, Gamma, Auto Exposure, White Balance, Flicker less, Image Orientation, Shutter Speed, Maximum Video Gain, D/N Sensitivity, Denoise, Defog, Metering	
Audio Compression	G.711, AAC (Optional)	
Audio Support	Two-way audio	
Video Resolution		
Main Stream	4:3	1600 x 1200, 1280 x 960, 640 x 480, 320 x 240
	16:9	1920 x 1080 (Default), 1280 x 720, 640 x 360, 448 x 252
	5:4	1280 x 1024, 640 x 512, 320 x 256
Sub Stream	4:3	640 x 480, 320 x 240
	16:9	640 x 360, 448 x 252 (Default)
	5:4	640 x 512, 320 x 256
TV-Out	NTSC, PAL (640 x 480 resolution)	
Network		
Interface	10/100 Base-T Ethernet, RJ-45 connector	

Protocol	HTTP, HTTPS, TCP, UDP, SMTP, FTP, DHCP, NTP, UPnP, DynDNS, 3GPP/ISMA, RTSP, PSIA, SNMP, QoS (DSCP), ONVIF (Profile S)	
<b>Mechanical</b>		
Temperature Detector	Yes	
Camera Adjustment	Pan	0° ~ 270°
	Tilt	0° ~ 70°
Connectors	Power	DC 48V, AC 24V (optional), High PoE (PoE++, 120 W)
	Ethernet	RJ-45
	Audio	1 In (microphone jack, 3.5 mm / 0.14") 1 Out (stereo phone jack, 3.5 mm / 0.14")
	Digital I/O	1 In / 1 Out
	TV-Out	BNC connector (640 x 480 resolution)
LED Indicator	N/A	
<b>General</b>		
Operating Temperature	-40°C ~ 50°C (-40°F ~ 122°F)	
Humidity	10% ~ 90% (non-condensing)	
Power Source	DC 48V, 2.5A, AC 24V 3A (Optional), High PoE (PoE++, 120 W) * If you require AC 24V 3A for optional operation, please specify upon ordering for the correct value of capacitance to be placed in the camera.	
Max. Power Consumption	50 W	
Dimensions	Without support rack	406 x 145 x 109 mm (16" x 5.7" x 4.3")
	With support rack	3.32 kg (7.32 lb)
Cable Length	1 m (3.28 ft)	
Weight	With support rack	3.32 kg (7.32 lb)
	Without support rack	2.62 kg (5.78 lb)
Ingress Protection	IP67	
Vandal Resistance	IK10 for metal casing	
Heater On	-40°C ~ 8°C (-40°F ~ 46.4°F)	
Fan	Constantly On	
Regulatory	CE, FCC, RCM, RoHS compliant	
<b>Power over Ethernet</b>		
PoE standard	High Power Over Ethernet (PoE ++ ) / PD	
PoE Power Supply Type	Mid-Span	
PoE Power Output	DC 48V, 2.5A (120 W Max.)	
<b>Web Interface</b>		
Installation & Management	Web-based configuration	
Firmware Upgrade	Remote upgrade through Web Browser GV-IP Device Utility included in the Software DVD	
Access from Web Browser	Live View, Video Recording, Video Quality, Bandwidth Control, Image Snapshot, Audio, Picture in Picture, Picture and Picture, Privacy Mask, Tampering Alarm, Text Overlay	
Language	Arabic / Bulgarian / Czech / Danish / Dutch / English / Finnish / French / German / Greek / Hebrew / Hungarian / Indonesian / Italian / Japanese / Lithuanian / Norwegian / Persian / Polish / Portuguese / Romanian / Russian / Serbian / Simplified Chinese / Slovakian / Slovenian / Spanish / Swedish / Thai / Traditional Chinese / Turkish	
<b>Applications</b>		
Network Storage	GV-System (GV-DVR/NVR), GV-VMS, GV-Recording Server	
Smart Device Access	GV-Eye for Android and iOS Embedded 3GPP/ISMA browser	
Live Viewing	IE, Chrome, Firefox, Edge, Safari	
CMS Server support	GV-Control Center, GV-Center V2, GV-Vital Sign Monitor	
LPR Management	GV-ASManager	

**Note:**





- Optionally purchasing GV-PA482 PoE Adapter is required for applying PoE function.

2. Try to avoid placing the camera where it can be subjected to direct LED light. The LED lighting from vehicles, streetlights, etc. may cause flickering images.
3. Specifications are subject to change without notice.

### Packing List

- The GV-LPC2210 camera
- Screw Anchor x 4
- Screw x 4
- Washer x 4
- Torx Wrench
- Power Adapter (DC 48V, 2.5A, 120 W)
- AC Power Cord
- Silica Gel Bag
- Adhesive tape for Silica Gel Bag
- GV-IP LPR Camera Software CD
- GV-NVR Software DVD
- GV-ASManager Software DVD
- GV-LPR Camera Installation Guide
- Warranty Card

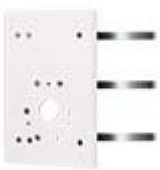
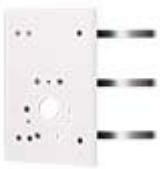
### Accessory

Model No	Name	Details	
GV-Mount300	Convex Corner Adapter Kit		Dimensions: 238.6 x 409.5 mm (9.4 x 16.1") Weight: 4.27 kg (9.41 lbs)
GV-Mount310	Concave Corner Adapter Kit		Dimensions: 123.3 x 393.1 mm (4.9 x 15.5") Weight: 2.96 kg (6.53 lbs)
GV-Mount400	Pole Mount Bracket Kit (Ø 4" ~ 6")		Bracket: 241 x 161 mm (9.5 x 6.3") Weight: 1.70 kg (3.75 lbs) Steel Strap Diameter: Ø 4" ~ 6"
GV-Mount410	Pole Mount Bracket Kit (Ø 6" ~ 7.5")		Bracket: 241 x 161 mm (9.5 x 6.3") Weight: 1.70 kg (3.75 lbs) Steel Strap Diameter: Ø 6" ~ 7.5"
GV-Relay V2	GV-Relay V2		The GV-Relay V2 is designed to expand the voltage load of GV IP devices. It provides 4 relay outputs, and each can be set as normally open (NO) or normally closed (NC) independently as per your requirement.

GV-POE Switch

The GV-POE Switch can be used for data transmission only. It does not provide power to GV-IP LPR cameras.

---

GV-PA482 PoE Adapter

The GV-PA482 PoE adapter is designed to provide power and network connection to GV-LPC2210 over a single Ethernet cable.

---