

I760xNxTx Series Surveillance Kits - NVR and Camera Kits

- Up to 5 Megapixel Resolution Recording
- 40 Mbps/60 Mbps Incoming Bandwidth
- Supports H.264+ and H.264
- Synchronous HDMI and VGA Output 1920 × 1080p Resolution
- 4/8-ch Network Cameras Can Be Connected
- 1 SATA Interface
- Plug & Play w/Up to 8 Independent PoE Network Connections
- Supports Network Detection, Including Network Delay, Packet Loss
- Alarm and Audio I/O



DS-2CD2342WD-I Outdoor Turret Camera (included with I7604N1TP and I7608N2TP Kits)



DS-2CD2120F-I Outdoor Dome Camera (included with I7604N1TA and - I7608N2TA Kits)



DS-7604NI-EV1/4P NVR (included with I7604N1TA and I7608N1TP Kits)



DS-7608NI-EV2/8P NVR (included with I7604N2TA and I7608N2TP Kits)

Each of the four Hikvision I760xN1Tx Surveillance Kits feature a Network Video Recorder (NVR) bundled with IP cameras for quick setup.

The kits are available with four channel (includes four cameras) or eight channel (includes six cameras) NVRs. Each dual stream NVR features 60 fps HDMI output, PoE+ connections, and two-way audio input.

The 2 megapixel dome or 4 megapixel turret cameras with 1/2.8" progressive scan CMOS sensors offer resolutions up to 1920 x 1080 (I7604N1TA and I7608N2TA) and 2688 x 1520 (I760N1TP and I7608N2TP).

Available Models: -

I7604N1TA: (1) DS-7604NI-EV1/4P NVR -
(4) DS-2CD2120F-I Outdoor Dome Cameras













I7608N2TA: (1) DS-7608NI-EV2/8P NVR
(6) DS-2CD2120F-I Outdoor Dome Cameras

I7604N1TP: (1) DS-7604NI-EV1/4P NVR
(4) DS-2CD2342WD-I Outdoor Turret Cameras

I7608N2TP: (1) DS-7608NI-EV2/8P NVR
(6) DS-2CD2342WD-I Outdoor Turret Cameras

| | I7604N1TA | I7604N1TP | I7608N2TA | I7608N2TP |
|------------------------------|---|--|---|--|
| ■ CAMERA | | | | |
| Camera Quantity | 4 | | 6 | |
| Model | DS-2CD2120F-I | DS-2CD2342WD-I | DS-2CD2120F-I | DS-2CD2342WD-I |
| Type | 2 megapixel CMOS vandal-proof network dome camera | | 4 megapixel CMOS network turret camera | |
| Lens | 2.8 mm @ f/2.0; angle of view: 106° | | | |
| Image Sensor | 1/2.8" progressive scan CMOS | 1/3" progressive scan CMOS | 1/2.8" progressive scan CMOS | 1/3" progressive scan CMOS |
| Min. Illumination | 0.028 lux @ f/2.0, AGC on, 0 lux with IR | | | |
| Shutter Speed | 1/3 s to 1/100,000 s | 1/3 s to 1/10,000 s | 1/3 s to 1/100,000 s | 1/3 s to 1/10,000 s |
| Lens Mount | M12 | | | |
| Day/Night | IR cut filter with auto switch | | | |
| Digital Noise Reduction | 3D DNR | | | |
| Wide Dynamic Range | Digital WDR | 120 dB | Digital WDR | 120 dB |
| Angle Adjustment | Pan: 0° to 355°, tilt: 0° to 75°, rotation: 0° to 355° | Pan: 0° to 360°, tilt: 0° to 75°, rotation: 0° to 360° | Pan: 0° to 355°, tilt: 0° to 75°, rotation: 0° to 355° | Pan: 0° to 360°, tilt: 0° to 75°, rotation: 0° to 360° |
| Compression Standard | | | | |
| Video Compression | H.264/MJPEG | H.264+, H.264, MJPEG | H.264/MJPEG | H.264+, H.264, MJPEG |
| H.264 Type | Main profile | | | |
| Video Bit Rate | 32 Kbps to 8 Mbps | 32 Kbps to 16 Mbps | 32 Kbps to 8 Mbps | 32 Kbps to 16 Mbps |
| Dual Stream | Yes | | | |
| Image | | | | |
| Max. Resolution | 1920 x 1080 | 2688 x 1520 | 1920 x 1080 | 2688 x 1520 |
| Frame Rate @ 60 Hz | 30 fps (1920 x 1080, 1280 x 720, 1280 x 720) | 20 fps (2688 x 1520), 30 fps (1920 x 1080, 1280 x 720) | 30 fps (1920 x 1080, 1280 x 720, 1280 x 720) | 20 fps (2688 x 1520), 30 fps (1920 x 1080, 1280 x 720) |
| Sub Stream | 60 Hz: 30 fps (320 x 240), 30 fps (352 x 288), 30 fps (640 x 480), 30 fps (704 x 576) | 60 Hz: 30 fps (352 x 240), 30 fps (640 x 360) | 60 Hz: 30 fps (320 x 240), 30 fps (352 x 288), 30 fps (640 x 480), 30 fps (704 x 576) | 60 Hz: 30 fps (352 x 240), 30 fps (640 x 360) |
| Image Settings | Rotate mode, saturation, brightness, contrast adjustable by client software or Web browser | | | |
| Backlight Compensation (BLC) | Yes, zone optional | | | |
| ROI | Supported | | | |
| Network | | | | |
| Network Storage | Local storage: Built-in microSD/SDHC/SDXC card slot, up to 128 GB. NAS (supports NFS,SMB/CIFS) | | | |
| Detection | Intrusion detection, line crossing detection, motion detection, dynamic analysis | | | |
| Alarm Trigger | Motion detection, tampering alarm, network disconnect, IP address conflict, storage exception | | | |
| Protocols | TCP/IP, ICMP, HTTP, HTTPS, FTP, DHCP, DNS, DDNS, RTP, RTSP, RTCP, NTP, UPnP, SMTP, IGMP, 802.1X, QoS, IPv6, Bonjour | | | |
| Security | User authentication, watermark | | | |
| Standard | ONVIF, CGI, ISAPI | | | |
| General | One-key reset, anti-flicker, dual stream, heartbeat, mirror, password protection, privacy mask, watermark, IP address filtering, anonymous access | | | |
| Interface | | | | |
| Communication Interface | 1 RJ-45 10M/100M Ethernet interface | | | |
| General | | | | |
| Operating Conditions | -30° C to 60° C (-22° F to 140° F); humidity 95% or less (non-condensing) | | | |
| Power Supply | 12 VDC ±10%, PoE (802.3af) | | | |
| Power Consumption | Max. 5.3 W | Max.: 5.5 W (7.5 W w/ICR on) | Max. 5.3 W | Max.: 5.5 W (7.5 W w/ICR on) |
| Ingress Protection level | IP67 | | | |
| IR Range | 100 ft (30 m) | | | |
| Impact Protection | IEC60068-2-75Eh, 20J; EN50102, up to IK10 | N/A | IEC60068-2-75Eh, 20J; EN50102, up to IK10 | N/A |
| Dimensions | Φ4.4" x 3.2" (111 mm x 82 mm) | Φ5.0" x 3.8" (Φ127 mm x 97.5 mm) | Φ4.4" x 3.2" (111 mm x 82 mm) | Φ5.0" x 3.8" (Φ127 mm x 97.5 mm) |
| Weight | 1.1 lb (500 g) | 1.5 lbs (670 g) | 1.1 lb (500 g) | 1.5 lbs (670 g) |

Accessories -

| DS-2CD2342WD-I Turret Camera | | | | | | |
|---|---|---|---|---|---|---|
|  |  |  |  |  |  | |
| Wall Mount WMS | Pendant Cap PC130T | Junction Box CBM | Inclined Ceiling Mount ABM | Corner Mount CM | Vertical Pole Mount PM | |
| DS-2CD2120F-I Dome Camera | | | | | | |
|  |  |  |  |  |  |  |

| | | | | | | |
|---------------------------------|-------------------|-------|-----|--------------|----------------------|---------------------|
| Inclined Ceiling Mount AB110 | Wall Mount WMS | PC110 | SRS | Shade SRS | Conduit Box CB110 | Wall Mount WM110 |
|---------------------------------|-------------------|-------|-----|--------------|----------------------|---------------------|

Specifications (continued)

| | I7604N1TA | I7604N1TP | I7608N1TA | I7608N1TP |
|---------------------------------|--|---------------------------|--|---------------------------|
| ■ NVR | | | | |
| Model | DS-7604NI-EV1/4P | | DS-7608NI-EV2/8P | |
| Video/Audio Input | | | | |
| IP Video Input | 4-ch | | 8-ch | |
| Two-Way Audio Input | 1-ch, RCA (2.0 Vp-p, 1k Ω) | | | |
| Network | | | | |
| Video Compression | H.264+, H.264 | | | |
| Incoming Bandwidth | 40 Mbps | | 60 Mbps | |
| Outgoing Bandwidth | 60 Mbps | | | |
| Remote Connections | 128 | | | |
| Video Output | | | | |
| Recording Resolution | 5 MP/3 MP/1080p/UXGA/720p/VGA/4CIF/DCIF/2CIF/CIF/QCIF | | | |
| Frame Rate | Main stream: 30 fps Sub-stream: 30 fps | | | |
| HDMI/VGA Output | 1-ch, resolution: 1920 × 1080p/1600 × 1200/1280 × 1024/1280 × 720/1024 × 768 | | | |
| Decoding | | | | |
| Live View Resolution | 5 MP/3 MP/1080p/UXGA/720p/VGA/4CIF/DCIF/2CIF/CIF/QCIF | | | |
| Playback Resolution Capability | 2-ch @ 1080p | 2-ch @ 720p, 2-ch @ 1080p | 2-ch @ 1080p | 2-ch @ 720p, 2-ch @ 1080p |
| Hard Disk | | | | |
| SATA | 1 SATA interface for 1 HDD | | | |
| HDD Included | 1 TB | 2 TB | | |
| Capacity | Up to 6 TB | | | |
| External Interface | | | | |
| Network Interface | 1 RJ-45 10/100/1000 Mbps self-adaptive Ethernet interface | | | |
| USB Interface | 1 × USB 2.0 and 1 × USB 3.0 | | | |
| Alarm In/Out | 4/1 | | | |
| PoE | | | | |
| Interface | 4 independent 100 Mbps PoE network interfaces | | 8 independent 100 Mbps PoE network interfaces | |
| Maximum Power | 50 W | | 120 W | |
| Supported Standards | 802.3af and 802.3at | | | |
| Other | | | | |
| Power Supply | 48 VDC, PoE+ (802.3at) | | 100 to 240 VAC, PoE+ (802.3at) | |
| Consumption (without hard disk) | ≤ 10 W | | | |
| Working Temperature | +14° F to +131° F (-10°C to +55° C) | | | |
| Working Humidity | 10% to 90% | | | |
| Chassis | 1U chassis | | | |
| Dimensions (W × D × H) | 12.4" × 9.1" × 1.8" (315 mm × 230 mm × 45 mm) | | 17.5" × 11.4" × 1.8" (445 mm × 290 mm × 45 mm) | |
| Weight (without hard disk) | ≤ 2.2 lb (1 kg) | | | |

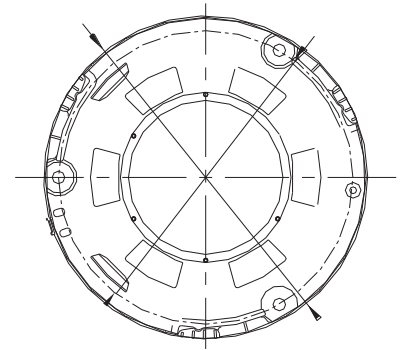
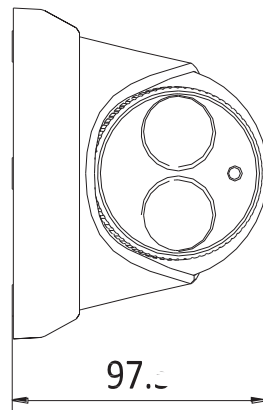

Ø112.4

Ø127

DS-2CD2342WD-I

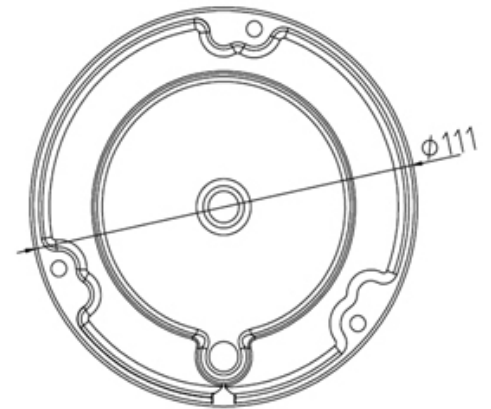
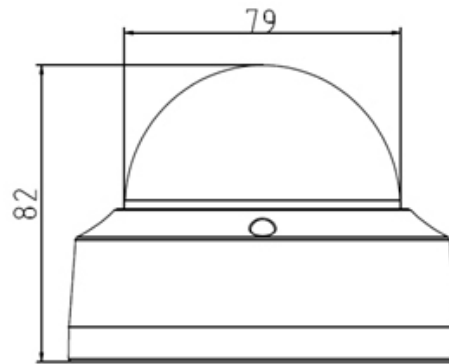

DS-2CD2120F-I

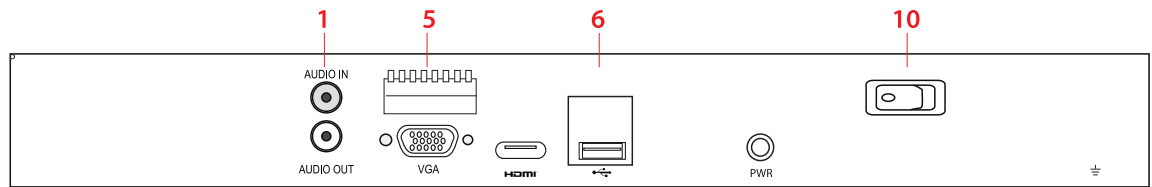

D - I - /4P

11 2 3 4 7 9 8

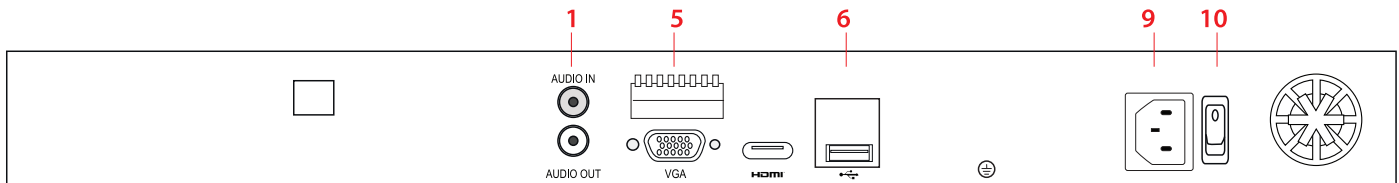

D - I - /8P

11 2 3 4 7 8

- | | | |
|--------------|-------------|--|
| 1. Audio In | 6. LAN | 5. Alarm I/O |
| 2. Audio Out | 7. USB | 10. Power Switch |
| 3. VGA | 8. Ground | 11. Network Interfaces with PoE Function |
| 4. HDMI | 9. Power In | |