

INSTRUCTION MANUAL

Color Camera

MODEL

ICD-525

ICD-525-TDN

OUTDOOR USE WARNING

WARNING – TO PREVENT FIRE OR ELECTRIC SHOCK, DO NOT EXPOSE THIS APPLIANCE TO RAIN OR MOISTURE.

The apparatus shall not be exposed to dripping or splashing and that no objects filled with liquids, such as vases, shall be placed on the apparatus.



Ikegami

Ikegami Tsushinki Co., Ltd.

Thank you for choosing this Ikegami ICD-525 Camera.

Please read this Instruction Manual carefully to keep your Ikegami camera at peak performance for longer service period.

This unit is a box -type 1 CCD (1/3") color camera which has also switchable monochrome mode from color mode for low light condition (as night).

Contents

	Page
1. Caution for Usage of Camera	1
2. General	2
3. Future.....	2
4. Name and Function of Each Part.....	4
5. Connection	6
5-1. Power cable (AC24V IN/DC12V IN).....	6
5-2. VIDEO OUT cable (VIDEO OUT)	6
6. Operation	7
6-1. User Setup.....	7
6-2. Names and functions of the setup buttons	7
6-3. Setup mode procedures	7
7. Focus EZ function	18
7-1. Screen Displays.....	18
8. Warranty and after sale service	19
9. Specifications	20
10.External Appearance	22
11.Setup Flow Chart	23



The exclamation point within an equilateral triangle is intended to alert the user to the presence of important operating and maintenance (servicing) instructions in the literature accompanying the appliance.

NOTE:

This equipment has been tested and found to comply with the limits for a Class A digital device, pursuant to part 15 of the FCC Rules. These limits are designed to provide reasonable protection against harmful interference when the equipment is operated in a commercial environment. This equipment generates, uses, and can radiate radio frequency energy and, if not installed and used in accordance with the instruction manual, may cause harmful interference to radio communications. Operation of this equipment in a residential area is likely to cause harmful interference in which case the user will be required to correct the interference at his own expense.

CAUTION;

ANY CHANGES OR MODIFICATIONS NOT EXPRESSLY APPROVED BY THE PART RESPONSIBLE FOR COMPLIANCE COULD VOID THE USERS AUTHORITY TO OPERATE THE EQUIPMENT.

Instructions for Disposal of Electrical and Electronic Equipment in Private Households



**Disposal of used Electric and Electronic Equipment
(Applicable in the European Union and other European countries with separated waste disposal and collection methods)**

This symbol on the product, or in the related documents in the package, indicates that this product shall not be treated as normal household waste.

Instead, it should be taken to a proper applicable collection point or depot for the recycling of electric and electronic equipment.

By ensuring this product is disposed of correctly, you will help prevent possible negative consequences for the environment and human health, which could otherwise be caused by inappropriate waste handling of this product. The recycling of materials will help to conserve natural resources.

For more detailed information about recycling of this product, please contact your local city authority, your household waste disposal service or the place where you purchased the product.

IMPORTANT SAFETY INSTRUCTIONS

- 1) Read these instructions.
- 2) Keep these instructions.
- 3) Heed all warnings.
- 4) Follow all instructions.
- 5) Do not use this apparatus near water.
- 6) Clean only with a dry cloth.
- 7) Do not block any of the ventilation openings. Install in accordance with the manufacturer's instructions.
- 8) Do not install near any heat sources such as radiators, heat registers, stoves, or other apparatus (including amplifiers) that produce heat.
- 9) Do not defeat the safety purpose of the polarized or grounding type plug. A polarized plug has two blades with one wider than the other. A grounding type plug has two blades and a third grounding prong. The wide blade or the third prong is provided for your safety. When the provided plug does not fit into your outlet, consult an electrician for replacement of the obsolete outlet.
- 10) Protect the power cord from being walked on or pinched particularly at plugs, convenience receptacles, and the point where they exit from the apparatus.
- 11) Only use the attachments/accessories specified by the manufacturer.
- 12) Use only with a cart, stand, tripod, bracket, or table specified by the manufacturer, or sold with the apparatus. When a cart is used, use caution when moving the cart/apparatus combination to avoid injury from tip-over.



- 13) Unplug this apparatus during lightning storms or when unused for long periods of time.

- 14) Refer all servicing to qualified service personnel. Servicing is required when the apparatus has been damaged in any way, such as power supply cord or plug is damaged, liquid has been spilled or objects have fallen into the apparatus, the apparatus has been exposed to rain or moisture, does not operate normally, or has been dropped.
- 15) CAUTION - These servicing instructions are for use by qualified service personnel only. To reduce the risk of electric shock, do not perform any servicing other than that contained in the operating instructions unless you are qualified to do so.

1. Caution for Usage of Camera

- Do not expose the camera/internal mechanism in the water/rain splashed and/or moisture environment.
- Do not use the camera where the ambient temperature under -10 Celsius or over 50 Celsius. The image and component parts of camera may be adversely affected and/or the camera may not function correctly.
- Do not remove the camera case, unless it is absolutely necessary for installing and/or adjusting the camera. The precision electrical and electronic components parts are inside the camera. The unneeded removing case is causing fault the camera, and/or accident (e.g. electric shock).
- Power off the camera before installing and electrical connection the camera.
- Do not drop camera and/or give the shock on camera which are in transit.
- Do not touch the surface of Image Sensor with hand/fingers.
- Do not aim the camera at Sun.
- In case under high temperature condition, it may appear the FPN (Fixed Pattern Noise) like rough on picture of camera. It is caused to Image Sensor characteristic, not indicate a technical problem.
- If the camera shoot the fine stripes object, it may appear the colored Interference fringe (Moire) on picture of camera. It is not indicate a technical problem.

2. General

This color camera is provided with a 1/3-inch approx. 480,000 pixels CCD sensor and equipped with the color/black-and-white picture out put switching. This camera produce the high quality color picture in a day light condition, and high sensitivity picture in the night.

This CCTV camera features wide dynamic range, high sensitivity and high resolution, and is equipped with Auto iris control function (can be selected suited auto iris lens) and other functions. The ICD-525 is best suited for general surveillance.

3. Future

- (1) High-quality picture and high resolution
The high resolution of a horizontal resolution of 700 TV lines is assured. The camera is designed for smear-free imaging and low noise. The well-designed DSP, Digital Signal Processor, effectively enhances details, which achieves crisp and sharp images with a high signal-to-noise ratio.
- (2) Day/Night change-over function
Depending on the surrounding brightness, the system automatically switches over images from high-quality color images in the day time to noise-reduced black and white images in the nighttime, always providing clear images around the clock.
- (3) Wide Light Dynamic Range (WDR)
The WDR function provides for very effective compensation of high light and dark areas in screen. This situation may occur generally outside or viewing from indoor to outdoor scenes. Even in large light fluctuations, bright-and-dark subjects can be captured and viewed clearly with a natural appearance.
- (4) Automatic white balance (ATW: Automatic Tracking White Balance Control)
Thanks to the automatic follow-up white balance control (ATW), the white balance adjusts itself no matter how great the subject's color temperature fluctuates.
- (5) AES (Automatic electronic shutter)
The AES function with sensitivity ratio of 1:1600 is incorporated for smooth sensitivity control by variable step control, allowing the stable video output equivalent to F1.5 to F50 Auto Iris to be obtained, even with a fixed iris lens.

- (6) Automatic iris control
This function is available control voltage for DC type auto iris lens. Almost all types of DC control auto iris CCTV lenses can be used.
- (7) Lens flange back focus adjustment
An easy adjustment can be done by a rotating lens mount mechanism, this may be useful to fix/use auto iris zoom lenses.
- (8) FOCUS EZ function
The level indicator is displayed to allow immediate judgment of focal point. In addition, the focus of the auto-iris lens is released to allow easy focusing without worrying about the depth of field even in a bright environment during the day light.
- (9) Optimum Monitor Output Select function
The optimum picture quality can be obtained with this unique function for CRT or LCD monitors. Sometimes, LCD, Liquid Crystal display type, Flat Screen.
Monitor with digital process function shows different display reproduction characteristics and you may choose this output selection to have the best pictures on the monitor screen. The level indicator is displayed to allow immediate judgment of focal point. In addition, the focus of the auto-iris lens is released to allow easy focusing without worrying about the depth of field even in a bright environment during the day light.

4. Name and Function of Each Part

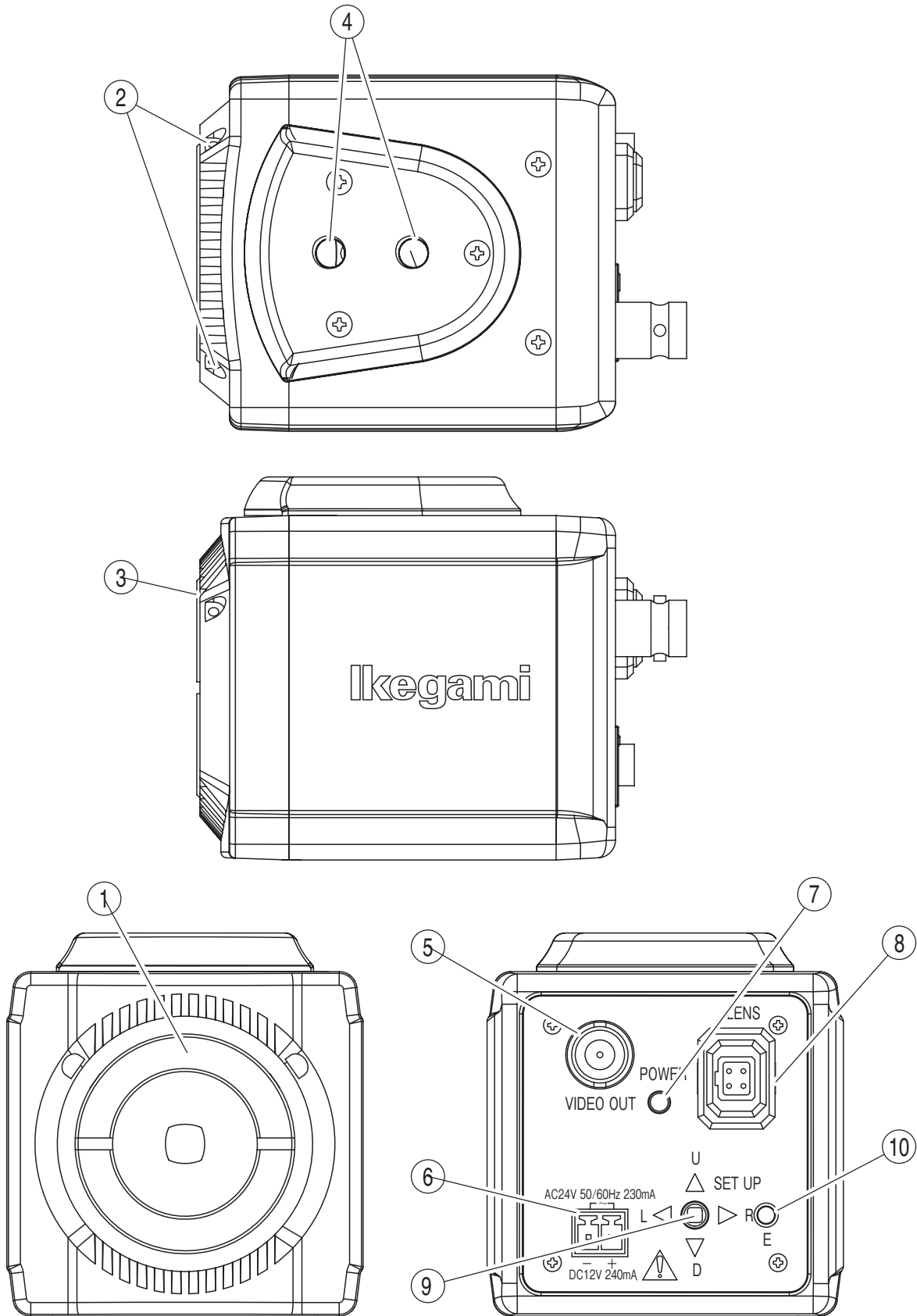

- ① Lens Mount (CS Mount)
Lens fixing Mount for various CS Mount lens (C-mount adaptor can be attached).
- ② Fixing screw for Lens flange back focus adjustment
Loose the screw before flange back focus adjustment, and tight after this adjustment.
- ③ Flange back focus adjustment mechanism
If it is unfocused picture even after adjust the focus ring of lens, flange back focus adjustment shall be done (adjust the depth between lens fixing surface and CCD image capture face).
- ④ The screw holes for camera holder/mount
These screw holes are for fixing the camera holder for wall or ceiling, also tripod for photo camera.

The fixing screw length for camera holder and tripod should be less than 5.5mm as follows (1/4"-20UNC) size screw.

- ⑤ Video Output connector (Video out)
Video signal out connector for monitor/switcher.
- ⑥ Power Input connector (non polarity)
Enter the power of AC24V IN ($\pm 10\%$)/DC12V (DC10.5V to 15V).
- ⑦ Power indicator
LED: It is lit green when power on.
- ⑧ Auto iris lens connector (for DC control iris lens only)
This connector is used for connecting DC Iris control cable plug (Applicable E4-191J-100 or equivalent) for DC type auto iris lens.

● DC Iris System

— Connector cable leads —

- 1. Damping coil (-)
- 2. Damping coil (+)
- 3. Driving coil (+)
- 4. Driving coil (-)

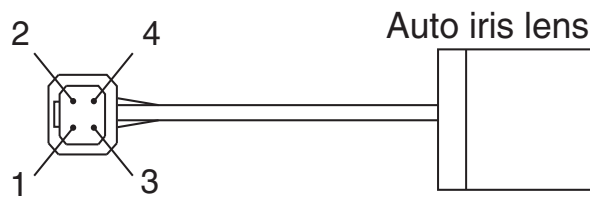

* Connect the leads as shown above.

Please refer also to the instruction manual of lens to be used.

- ⑨ to ⑩ Button for Set up
See page 7 "Operation".

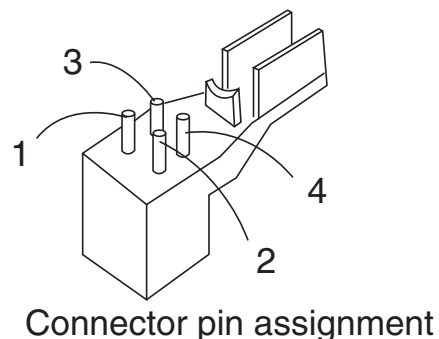

5. Connection

5-1. Power cable (AC24V IN/DC12V IN)

- AC24V ($\pm 10\%$), DC12V Connector (10.5V to 15V):
Connect to DC power supply.

5-2. VIDEO OUT cable (VIDEO OUT)

The VIDEO OUT connector is output only camera Video signal for monitor, switcher and etc. Connect to video in connector for monitor, switcher and etc with BNC coaxial cable.

6. Operation

6-1. User Setup

The ICD-525 camera is provided with user setup function for picture quality, and camera ID. The setup menu is a tree type on-screen-display. When installing the camera it is possible to set up the various functions.

6-2. Names and functions of the setup buttons

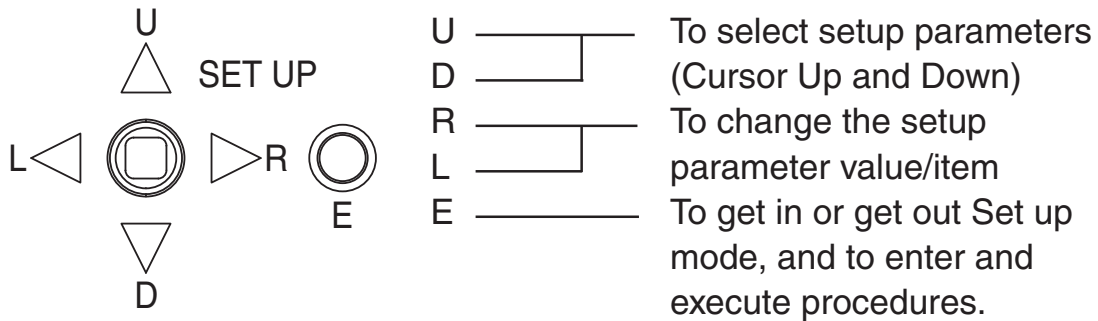

*To get into Setup mode ,hold “E” button more than 2 seconds.

6-3. Setup mode procedures

Hold down the enter “E” button longer than 2 seconds, and the setup menu screen appears on screen. A blue highlighted (cursor) item is now selected (other item is selectable with “U” or “D” button).

Use the “L” or “R” buttons to change the value or select the set item of setup parameters.

6-3-1. SET UP MENU 1/3 (LANGUAGE selected ' ENGLISH')

EXIT : Quit the Menu and save the changed value/set data on Menu.

RESET : Default the all data (back to factory setup condition).

SETUP MENU	
1. PAGE	1/3
2. LENS	DC↓
3. EXPOSURE↓	
4. BACKLIGHT	WDR↓
5. WHITE BAL	ATW↓
6. DNR	ON↓
7. DAY/NIGHT	AUTO↓
EXIT	RESET

1. PAGE



Used to change the page of Setup menu.

2. LENS

DC/MANUAL : Select used lens type.

Usually set "DC".

1. IRIS : Adjust the iris level for DC control iris lens. (value : 0 to 31)
2. SPEED : Adjust the control speed for DC iris lens. (value : 0 to 255)
3. RETUEN : Back to SETUP MENU screen.

DC LENS	
1. IRIS	 006
2. SPEED	 034
3. RETURN↓	

If it is changed the value for above DC LENS value, it may cause the picture brightness changing. Do not touch this adjustment item except service engineer.

3. EXPOSURE

1. SHUTTER : Select the Shutter mode.
 --- : Fix the shutter speed 1/60 second.
 A.FLK : Select when the flicker on picture.
 ESC : Select when manual iris lens is used.

EXPOSURE	
1. SHUTTER	 ---
2. AGC	MIDDLE
3. SENS-UP	AUTO↓
4. RETUEN↓	

Do not select "AES" when DC auto iris lens is attached and used.

Manual : Set the fixed shutter speed 1/60 to 1/120000 second.

2. AGC (AUTO GAIN CONTROL) : Select/set the gain level between OFF, LOW, MIDLOW, MIDDLE, MIDHIGH, HIGH.
High level AGC gain can display brighter picture, although noise can more readily increase.
3. SENS-UP : Automatically up the brightness of picture where dark place like night condition by electric charge accumulation.
OFF : Inactivate SENS-UP function.
AUTO : Activate SENS-UP function.
 1. AUTO : Set the sensitivity up level x2, x4, x6, x 8, x10, x12, x14, x16, x24, x32.

*The high value can display brighter picture, although the blur of moving object will be appear .
*During this setup the picture will be noisy and/or whitish, it is not indicate a technical problem.

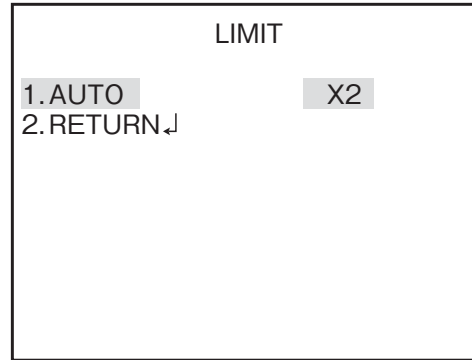

2. RETURN : Back to SETUP MENU screen. From below “RETURN” explanation is omitted.

4. BACK LIGHT

OFF : No function of BLC.

BLC : Usual function of BLC.

WDR : If the picture shows still white saturation on it and see hard for details of picture even set above “BLC” on camera, set “WDR”.

1. LIMIT : Select and set the Sensitivity for WDR LOW, MIDLOW, MIDDLE, MIDHIGH, HIGH
2. LEVEL : Set the brightness of WDR icture. (value 0 to 20)
3. ANTI ROLLING : Reduce the “Color rolling“ around the fluorescent lamp on picture.
OFF : Inactivate “ANTI ROLLING” function.
ON : Activate “ANTI ROLLING” function.

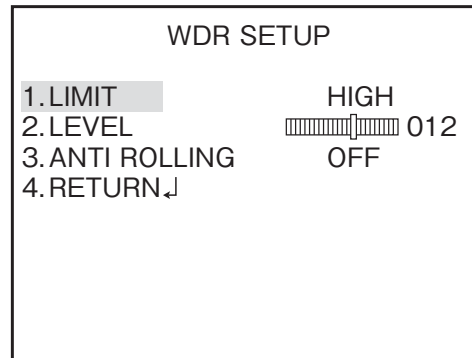

-WDR effect

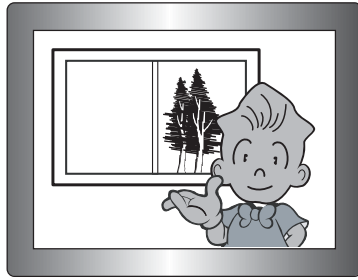

WDR ON

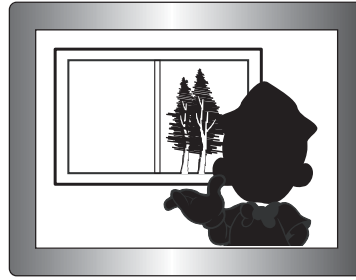

WDR OFF

1. "WDR" is functioned with "SHUTTER" mode set (----).
2. "WDR" function is influenced the size of high light area.
The camera installing place and angle shall considered this point.
3. Color rolling phenomenon is colored picture around the fluorescent lamp randomly appeared. It is caused flicker of fluorescent lamp by Alternate current power as usual.

5. WHITE BAL (WHITE BALANCE)

ATW : Auto tracking white balance for scene.

1. **SPEED** : Set the speed of tracking speed for auto white balance. The value is 0 to 255.
2. **ENVIRONMENT**
INDOOR : Select when indoor scene/object is mainly for camera.
OUTDOOR : Select when outdoor scene/object is mainly for camera.

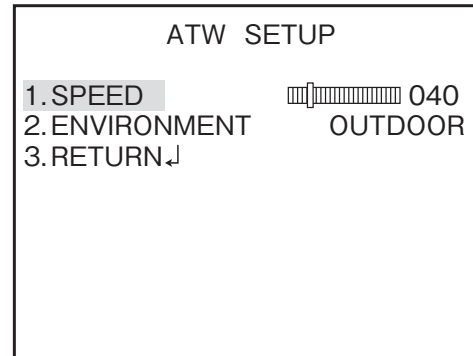

Out door scene condition for is changing harder than indoor condition, as influence weather sun light (changed time go by). Thus set "OUTDOOR" for outdoor use camera.

AWC PUSH : This is so-called "one-push automatic white balance control".

Shoot the white subject and press the "E" button, and the white balance will be adjusted. After this adjustment, if the color temperature for subject is changed, this white balance data is not changed and not followed. This function shall be used for same lighting condition for subject.

MANUAL : The white balance is adjusted by manually. Select and press E button, then left screen displayed.

1. RED : Adjust the reddish color.
2. BLUE : Adjust the bluish color.

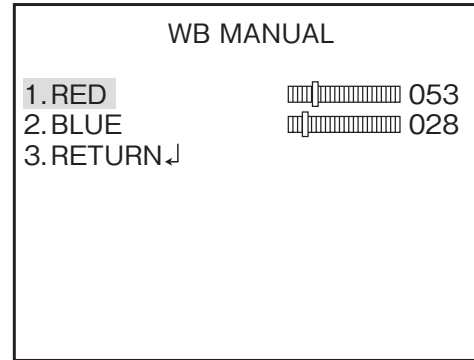

The ATW mode may not work correctly under following lighting conditions. In this case, select AWC and adjust the white balance.

- ① The lighting condition (color temperature) is out of control span of ATW (e.g. clear blue sky, before/after Sun rise/Sun set)
- ② Too low lighting condition for subject.
- ③ The white balance function may not work of stability when the camera aim the fluoresce lamp or under extremely/rapidly change lighting condition.

6. DNR (Digital Noise Reduction)

OFF : No function of DNR.

ON : Function of DNR.

1. LEVEL: Adjust the noise reduction Level. Adjusting value 0 to 20.

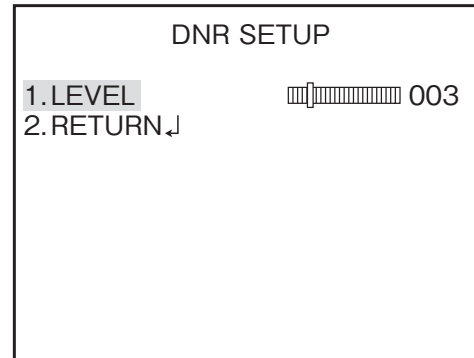

Note: Higher reduction value may caused the blur phenomenon of moving subject on picture.

7. DAY/ NIGHT

AUTO : Automatic switching is made high quality color picture in the day, and high sensitivity monochrome pictures at night.

1. DWELL TIME : Adjust the transition time between DAY and NIGHT mode. Adjusting value 0 to 20.

COLOR : COLOR Mode fixed.

B/W : Monochrome Mode fixed.

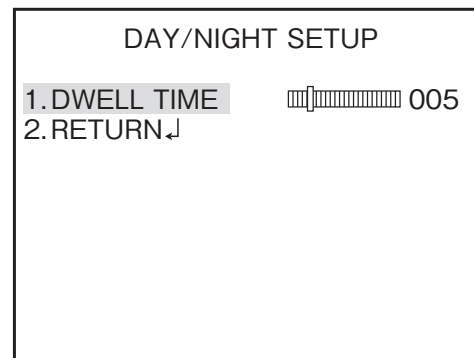

6-3-2. SET UP MENU 2/3 (LANGUAGE selected' ENGLISH')

SETUP MENU	
1. PAGE	2/3
2. IMAGE ADJ ↓	
3. PICTURE ADJ ↓	
4. CAMERA TITLE	OFF
5. D-ZOOM	OFF
6. MOTION DET	OFF
7. PRIVACY MASK ↓	
EXIT	RESET

1. PAGE

Change the page of Setup menu.

2. IMAGE SETUP

1. FREEZE

OFF : Inactivated freeze function.

ON : The picture is frozen.

2. MIRROR

OFF : Output normal picture.

V-FLIP : Inverse Up/Down side of picture.

H-FLIP : Inverse Left/Right side of picture.

HV-FLIP : Rotate 180 degree of picture.

3. RESOLUTION

NORMAL : Set the resolution of picture as usual.

HIGH : Set the resolution of picture as high resolution.

4. PEDESTAL

7.5IRE : Set the Pedestal level 7.5IRE of Video signal.

0 IRE : Set the Pedestal level 0IRE of Video signal.

IMAGE SETUP	
1. FREEZE	OFF
2. MIRROR	OFF
3. RESOLUTION	NOMAL
4. PEDESTAL	7.5IRE
5. RETURN ↓	

3. PICTURE SETUP





1. R-GAIN : Adjust reddish of picture (value 0 to 15).

2. B-GAIN : Adjust bluish of picture (value 0 to 15).

3. HUE: Adjust hue of picture (value 0 to 15).

4. CONTRAST: Adjust contrast of picture (value 0 to 63).

5. SHARPNESS: Adjust sharpness of picture (value 0 to 15).

PICTURE SETUP	
1. R-GAIN	 010
2. B-GAIN	 010
3. HUE	 008
4. CONTRAST	 035
5. SHARPNESS	 008
6. COLOR GAIN	MIDDLE
7. GAMMA	0.55
8. RETURN ↓	

6. **COLOR GAIN:** Adjust/set the color level of picture.
OFF: (No gain up the color level)/LOW/ MIDDLE/ HIGH
7. **GAMMA:** Adjust/set the Gamma correction value of picture
between 0.38 / 0.42 / 0.45 / 0.50 / 0.55 / 0.63 / 0.71 / 0.83 / 1.0.
Note :The lower value for GAMMA above, realize to display more
brighter for dark section of picture, but it cause noise level
up bit and reduce the graduation for bright section of picture.

4. CAMERA TITLE

Used to set the camera /site name, allows up to.52 alphanumeric (26 alphanumeric /1 line, 52 alphanumeric /2 line on screen).

OFF :No display on screen.

ON :Display on screen.

● Setting TITLE

CAMERA TITLE : Set “ON” and press “E” button for display right shown screen. Select the needed character with L, R, U, D button and press “E” button. And the cursor for TITLE is stepped to next letter position.

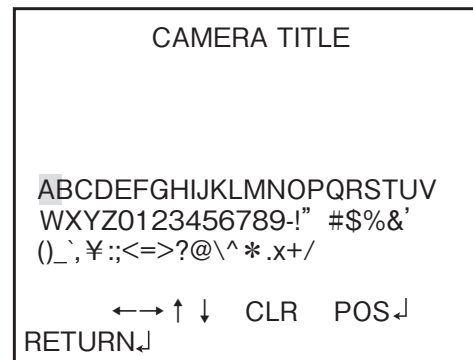

● Erase 1 letter by 1 letter

Move the cursor with ← → on erasing needed letter and “CLR” + “E” button.

● POSITION

Move the cursor on “POS” and press “E” button then Title displayed on screen.

Set the Title display position with L, R, U, D button and determine press “E”.

No display the TITLE on screen when set “OFF” for CAMERA TITLE.

5. D-ZOOM (Digital Zoom Up)

Set the Zoom up magnify power for center of picture.

OFF : Inactivate D-Zoom function (same as with “ON” SET x1).

ON : D-Zoom functioned.

1. Set the magnify power between x1 to x32.

If “DIS” stabilizer (6-3-3 item3 page 22) is set ON, D-ZOOM is not functioned.

6. MOTION DET (MOTION DETECTION)

Detect the changing of picture (moving subject) function.

OFF : Inactivate MOTION DET function.

ON : MOTION DET functioned.

1. **DETECT SENSE** : Adjust the detect sensitivity for moving subject. Higher value setting, more sensitivity of detection (value 0 to 127).
2. **BLOCK DISP** : Display the block screen for detected Area of picture.
OFF : Inactivate BLOCK DISP function.

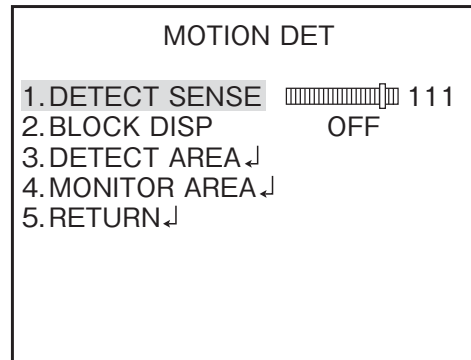

- ON : Display the block screen for detected area of picture.
3. **DETECT AREA** : Set the detection area on picture (8 x12 blocks).
Detection area picture is inverted negative picture.
The cursor on picture (block) can be moved with L, R, U, D button, and determined the detection area on picture by pressing “E” button.

4. **MONITOR AREA** : Set non detect Area (Up to 4 areas) on picture.
 1. **AREA SEL** : Set 4 non detect areas. 1/4 Red frame, 2/4 Green, 3/4 Violet, 4/4 Yellow.
 2. **MODE** : Active non detect area.
 3. **TOP** : Set top frame position.
 4. **BOTTOM** : Set bottom frame position.
 5. **LEFT** : Set left frame position.
 6. **RIGHT** : Set right frame position.
Selection of up and down (0 to 15).
Selection of the right and left (0 to 23).

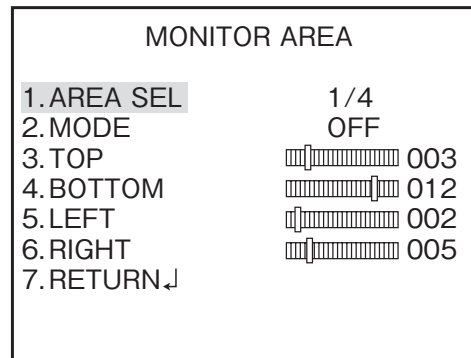

7. PRIVACY MASK

Set the privacy mask up to 15 masks on picture.

1. **AREA** : Select the setting privacy mask between 1/15 to 15/15.
2. **MODE** : Set privacy mask display or non display on picture.
OFF : No display the privacy mask.
ON : Display the privacy mask, and below setting is valid.
3. **POSITION** : Set the position and size for privacy mask following sub menu screen.

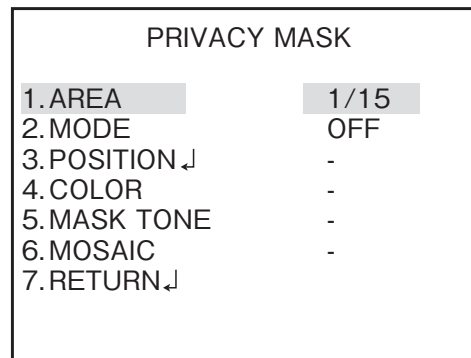

4. **COLOR** : Select/set the coloring for privacy masking area.
The color can be selected between 8 colors WHITE, BLACK, RED, GREEN, BLUE, YELLOW, CYAN, MAGENTA.
5. **MASK TONE** : Select/set the translucent ratio of privacy mask.
0.00 (clear: no displayed masking area except ON set of MOSAIC), 0.50, 0.75, 1.00 (opaque for behind picture).
6. **MOSAIC** : Mosaic display for privacy mask area on picture except set 1.00 for above MASK TONE.
– : Invalid Mosaic setting (set 1.00 for above MASK TONE).
OFF : No display mosaic privacy masking area.
ON : Display mosaic privacy masking area.

6-3-3. SETUP MENU 3/3 (LANGUAGE selected' ENGLISH')

SETUP MENU	
1. PAGE	3/3
2. MONITOR	LCD
3. DIS	OFF
4. SYNC	INT
5. VIDEO ADJ.↓	
6. LANGUAGE	ENGLISH
EXIT	RESET

1. PAGE

Change the page of Setup menu.

2. MONITOR

The optimum picture quality can be selected according to the monitor used.

LCD : Set. when the camera video signal is connected LCD monitor.

CRT : Set when the camera video signal is connected with CRT (cathode ray tube)monitor.

3. DIS (Digital Image Stabilizer)

Stabilize the shaking picture on screen caused camera (housing) shacking by wind e.g.

OFF : Invalid DIS function.

ON : Valid DIS function.

- The resolution of picture is reduce for using part of function Digital Zoom.
- This DIS may not functioned under low light condition for subject.
- This DIS may not functioned for simple subject like Sky, white wall.
- When DIS is set ON, invalidated the Digital Zoom and MOTION DETECTION function.

4. SYNC (SYNCHRONIZATION SYSTEMS)

Select the synchronization system either INT (by Internal crystal OSC) or LL (by AC power line frequency).

Especially using this camera in Japan, the "INT" shall be selected.

Because there are 50Hz power system and 60Hz power system in Japan.

- This camera shall be set "INT" on this menu setup.
- If it is set "LL", it may caused unstable picture on screen.

5. VIDEO ADJ

Set the each level of video signal.

1. SYNC : Adjust the Sync signal level (value 0 to 40).
2. BURST : Adjust the Burst signal level (value 0 to 30).
3. CLIP : Adjust the Video signal level (value 0 to 40).

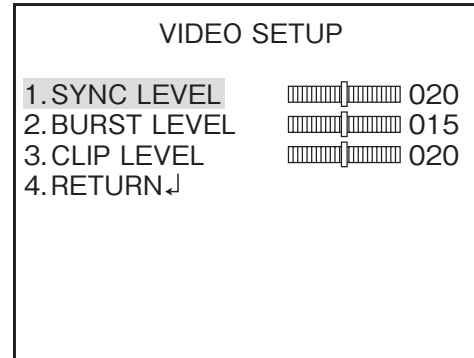

6. LANGUAGE

Select the language to display the SETUP MENU.

日本語 : In Japanese SET UP MENU.

ENGLISH: In English SET UP MENU.

7. Focus EZ function

7-1. Screen Displays

FOCUS EZ is a function to support focus adjustment. A focus indicator displayed on the screen can be used to confirm the focus conditions. In case of auto-iris, it is possible to open the lens aperture forcibly for a set time period to carry out focus adjustment without worrying about field of depth even in a bright environment during the day. (The camera sensitivity is adjusted automatically, and there is no influence on the displayed image).

Press the U button for over two seconds to start FOCUS EZ and go to the focus adjustment screen.

FOCUS EZ can not be started in the SETUP mode.

Focus adjustment screen

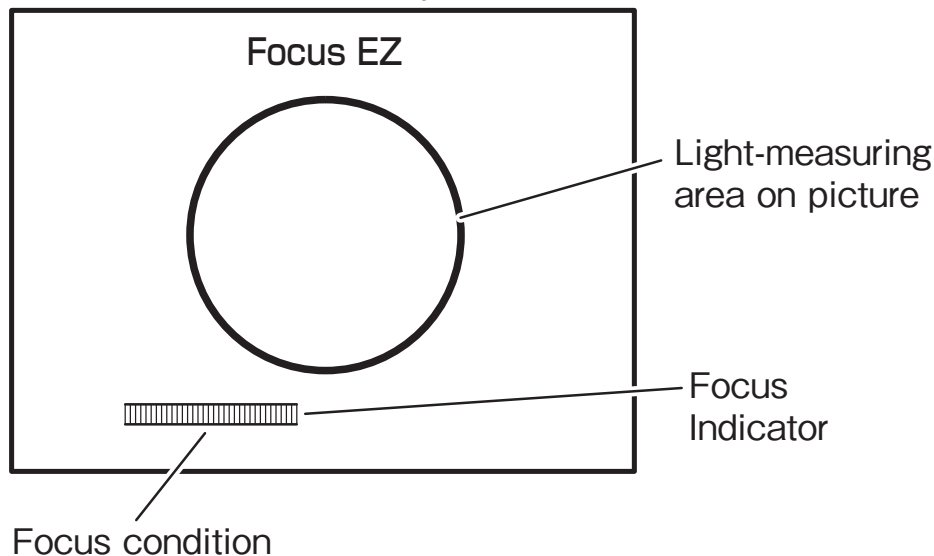

While viewing the focus indicator on the focus adjustment screen, it is possible to adjust the focus. Displayed the focus indicator is shown the present focus condition. Adjust the focus so that the focus indicator reaches the Maximum point.

Pressing the D button once during FOCUS EZ operation terminates FOCUS EZ.

If the camera shoot the monotonous subjects like Sky, white wall, it may caused no extending the Focus indicator.

This does not indicate a malfunction of camera.

8. Warranty and after sale service

A warranty accompanies this product. Read and fill out the warranty card that you have received at your dealer. Keep this card in a safe place.

- Please consult Ikegami Electronics (U.S.A.) Inc. or Ikegami Electronics (Europe) GmbH or your dealer for full warranty information. Your dealer will repair or replace free of charge within the warranty period according to the warranty coverage.
 - For repairs after the expiration of the warranty period, consult your dealer or sales representative. It will first be judged whether the fault is repairable or not. Charged servicing will then be made upon request of the user.
 - Before you ask for servicing, please ensure you read the Instruction Manual. If the unit still fails, take note of the model number, date of purchase, problem, etc. in detail, and inform your dealer or sales representative.
 - If you have questions about the after-sale service, contact your dealer or sales representative.
- * We suggest you ask for preventive inspection as soon as possible.

9. Specifications

- | | |
|--------------------------------------|---|
| (1) Image Sensor: | 1/3-inch CCD sensor |
| (2) Pixel Number: | NTSC: 976 (H) × 494 (V), Approx.480,000 pixels |
| (3) Scanning system: | NTSC: 525 lines/ 59.94Hz, 2:1 interlace |
| (4) Sync system | INT (Crystal-lock), or
LL (line lock /phase adjustable): LL is not usable where 50Hz power frequency or DC 12V power driven. |
| (5) Video output: | VBS 1.0Vp-p/75 Ω |
| (6) Resolution: | Horizontal: Over 700TV lines (High-resolution mode, rating illumination) |
| (7) S/N Ratio: | Over 52dB (p-p/rms) |
| (8) Minimum illumination: | 0.22Lx/F1.2 (SENS-UP: OFF, VBS output: 50%)
0.007Lx/F1.2 (SENS-UP: x32, VBS output: 50%) |
| (9) Day/Night switching: | ICD-525 : Digital Day/Night
ICD-525-TDN : True Day/Night |
| (10) Wide Dynamic Range: | LOW/MIDLOW/MIDDLE/MIDHIGH/HIGH
Selectable from 6 steps above. |
| (11) AGC: | OFF/LOW/MIDLOW/MIDDLE/MIDHIGH/
HIGH Selectable from 6 steps |
| (12) Electronic Sensitivity Control: | Built in, ON(AUTO)/OFF Selectable
Maximum 32 times |
| (13) White Balance Cont.: | ATW/AWC/MANUAL Selectable |
| (14) DETAIL correction: | Built in (SHARPNESS function) |
| (15) Noise Reduction: | Built in, ON/OFF Switchable (NDR function) |
| (16) AES: | Built in |
| (17) Privacy Mask setting: | Built in, (Up to 15 areas) |
| (18) MIRROR: | Built in, OFF/ H / V / H&V Selectable |
| (19) Motion Detection: | Built in, ON/OFF Switchable |
| (20) Digital Zoom: | Built in, ON/OFF Selectable (x32 Maximum) |
| (21) Focus adjust support: | Built in, (FOCUS EZ function) |
| (22) Image Stabilizer: | Built in, (DIS function) |
| (23) Monitor output Selection: | CRT/LCD Switchable |
| (24) Camera ID: | Up to 26 alphanumeric/1 line, 2 lines |
| (25) Local Setup : | Use the buttons on the rear panel of camera and operate the screen Setup menu display. |
| (26) Lens Mount: | CS Mount
(C-mount adapter attachment possible) |
| (27) Lens flange back Adjustment: | Built in |

- (28) Power Requirement: AC24V±10%, 60Hz / DC12(10.5 to 15V)
- (29) Current Consumption: AC24V: 3W
DC12V: 3W
- (30) Operating Temperature
and Relative Temperature: -10 ~ +50°C / 30 ~ 90%RH (No Condensation)
- (31) Camera Mount: 1/4"-20UNC (this mount part is changeable
to fix on Top or Bottom side of camera.)
- (32) Outer dimensions: 60mm (W) × 58mm (H) × 70mm (D)
(No protrusion included)
- (33) Weight: Approx. 240g
- (34) Input/Output connectors: VIDEO OUT BNC
AC24V/DC12V IN 2-Pin terminal block
- (35) Supplied accessories: Instruction Manual
Allen wrench (for flange back adjustment)
Power input connector

10. External Appearance

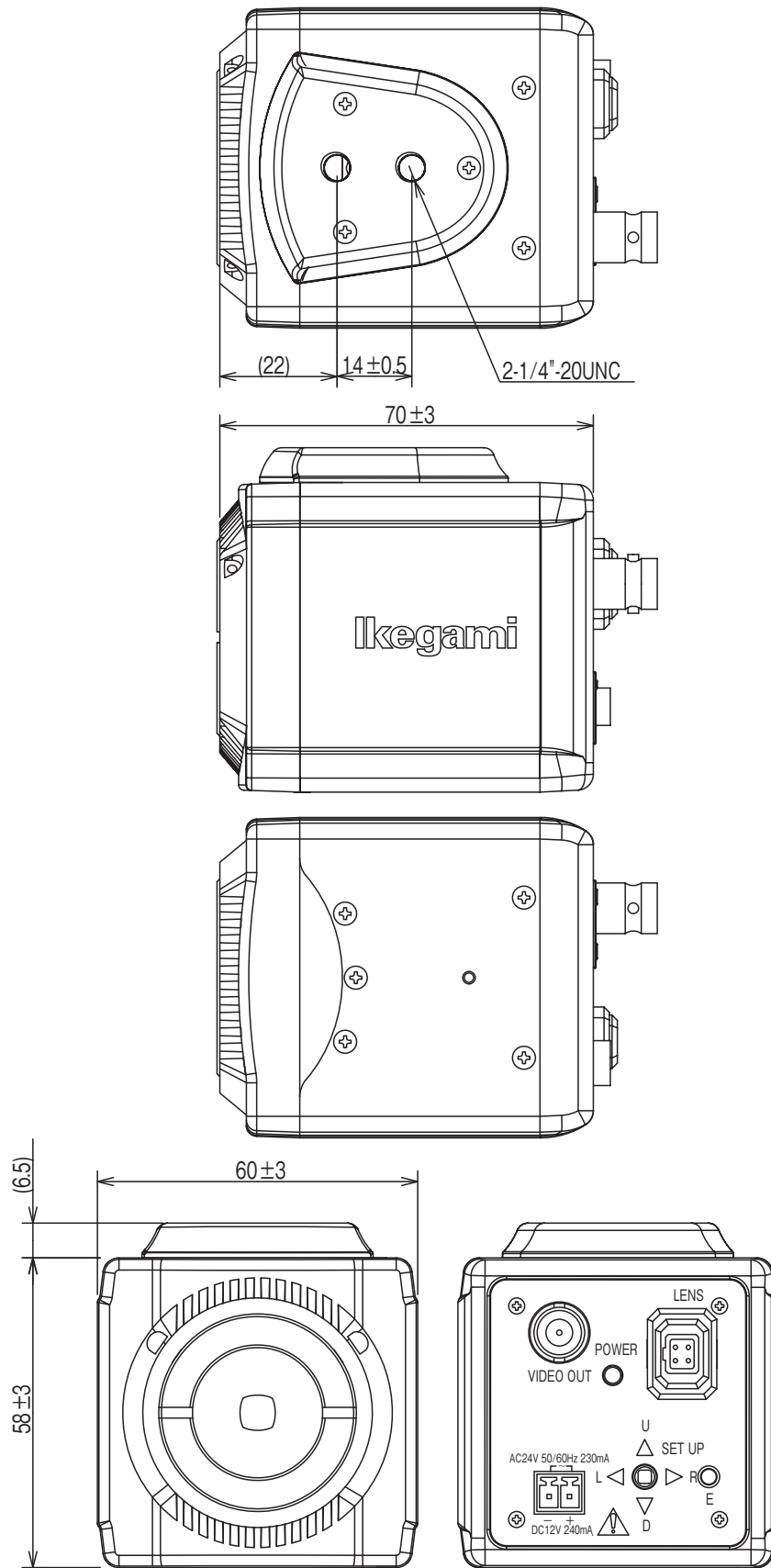

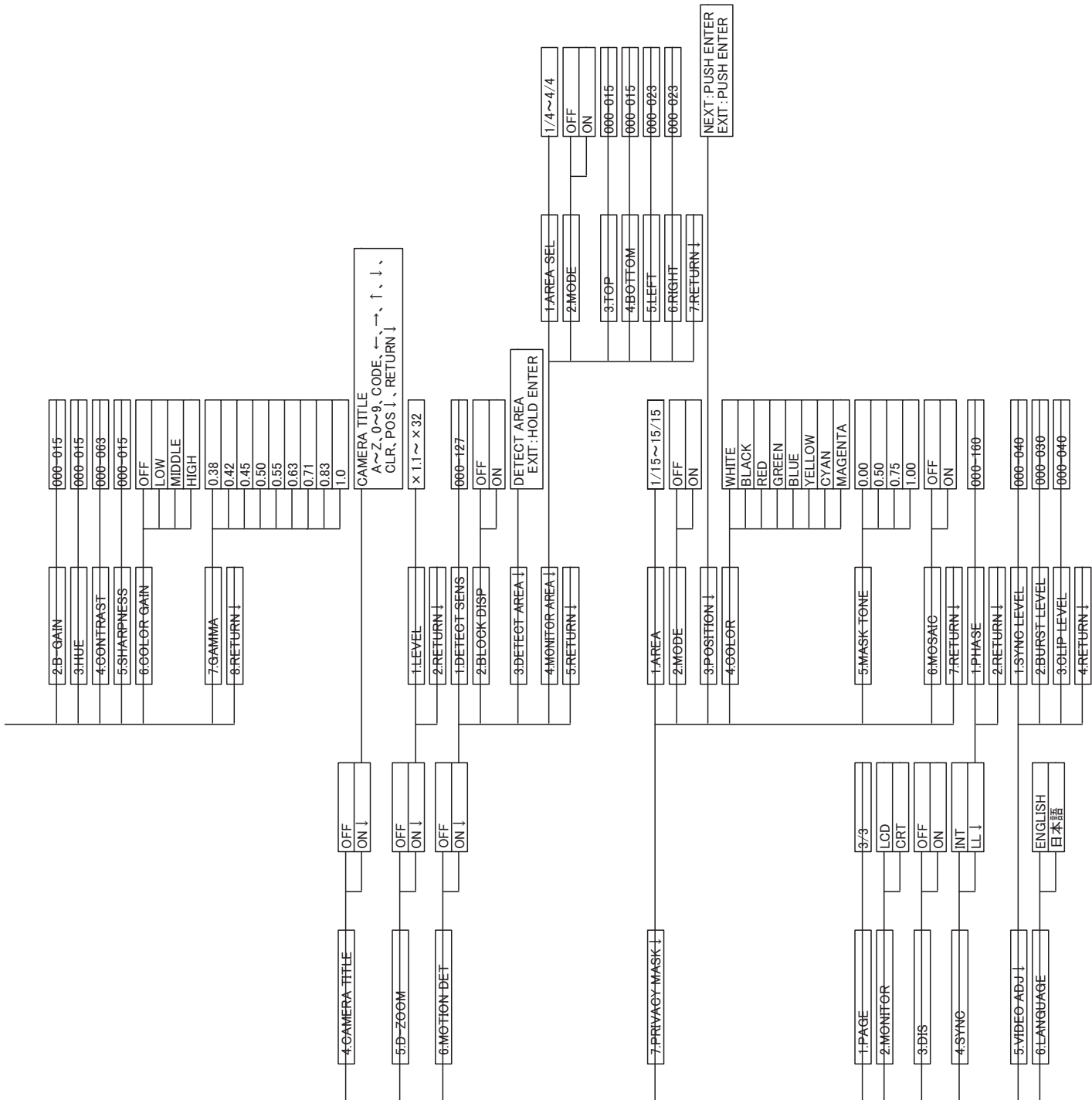

MEMO

MEMO

Ikegami

■ **Ikegami Electronics (U.S.A.), Inc.**

37 Brook Avenue, Maywood, N.J. 07607, U.S.A.
Phone: (201) 368-9171, FAX (201) 569-1626
www.Ikegami.com

or

■ **Ikegami Electronics (Europe) GmbH**

Ikegami Strasse 1, D-41460 Neuss, Germany
Phone : 02131-123-0, FAX 02131-102820
www.Ikegami.de

■ **Ikegami Electronics U.K. Office:**

Unit E1, Cologne Court, Brooklands Close,
Windmill Road, Sunbury-on-Thames,
Middlesex, TW16 7EB, U.K.
Phone:01932-769700 FAX 01-92-769710
www.Ikegami.co.uk



Ikegami Tsushinki Co., Ltd.
NNA005266-00