

GV-GBLF4802 AI 4MP H.265 Super Low Lux WDR Pro Full Color Warm LED IR

Bullet IP Camera



- AI deep learning: Smart Perimeter Protection & Classification (Human, Vehicle)
- 1/3" progressive scan CMOS sensor
- Min. illumination at 0.005 lux
- Triple streams from H.265, H.264 or MJPEG
- Up to 30 fps at 2560 x 1440
- Wide Dynamic Range Pro (WDR Pro)
- Smart warm LED distance up to 30 m (100 ft)
- Intelligent IR
- IR distance up to 30 m (100 ft)
- Ingress protection (IP67)
- Vandal resistance (IK10 for metal casing)
- Built-in microphone
- Built-in microSD card slot (SD / SDHC / SDXC) for local storage
- DC 12V / PoE (IEEE 802.3af)
- AI analytics (Line Crossing, Region Intrusion)
- Smart lighting switch between IR LED (for motion detection) and Warm LED (for people, vehicle and motorcycle detection)
- 3D noise reduction
- Motion detection
- Text overlay
- Privacy mask
- 21 languages supported
- ONVIF (Profile G, S, T, M) conformant

Introduction

GV-GBLF4802 is a 4 MP outdoor bullet IP camera, equipped with a smart warm LED for full color surveillance during nighttime. The camera supports H.265 video codec to achieve a better compression ratio while maintaining high-quality pictures at reduced network bandwidth. GV-GBLF4802 adheres to IP67 and IK10 standards and can be powered through PoE.

Empowered by deep learning algorithms, AI technology distinguishes humans and vehicles from other moving objects. Integrated with GeoVision Video Management Software (GV-VMS), it supports AI perimeter protection, real-time alert, playback, and more.

Models

Model	Iris	Focal Length (mm)	Horizontal FOV	Maximum Aperture	Image Format
GV-GBLF4802-2F	Fixed	2.8 mm	94°	F/1.6	1/3"
GV-GBLF4802-3F		3.6 mm	78°		

Deep Learning Function

AI Perimeter Protection (Line Crossing, Region Intrusion)



Specifications

Camera					
Image Sensor		1/3" progressive scan CMOS			
Picture Elements		2560 (H) x 1440 (V)			
Minimum Illumination	Color	0.005 Lux (F1.6, AGC ON)			
	IR On	0 Lux			
Shutter Speed		Auto / Manual (1 ~ 1/100000 sec)			
White Balance		Auto / Manual			
Gain Control		Auto / Manual			
S/N Ratio		50 dB			
WDR Pro		Yes			
Dynamic Range		120 dB			
Lens		GV-GBLF4802-2F	GV-GBLF4802-3F		
Megapixel		4 MP			
Day / Night		Yes (with removable IR-cut filter)			
Lens Type		Fixed			
Focal Length		2.8 mm	3.6 mm		
Maximum Aperture		F/1.6			
Mount		M12			
Image Format		1/3"			
FOV	Horizontal	94°	78°		
	Vertical	50°	40°		
	Diagonal	115°	97°		
Operation	Focus	Fixed			
	Zoom	Fixed			
	Iris	Fixed			
IR LED	Quantity	1 IR LED			
	Max. IR Distance	30 m (100 ft)			
Smart Illumination	Quantity	1 Warm LED			
	Max. Warm LED Light Distance	30 m (100 ft)			
DORI		Detect	Observe	Recognize	Identify
Lens	2.8 mm	62 m (203.4 ft)	25 m (82.0 ft)	12 m (39.3 ft)	6 m (19.6 ft)
	3.6 mm	79 m (259.1 ft)	32 m (104.9 ft)	16 m (52.4 ft)	8 m (26.2 ft)
Operation					
Video Compression		H.265, H.265+, H.264, H.264+, MJPEG			
Video Streaming		Triple streams			
Video Resolution	Main Stream	2560 x 1440 (default), 2304 x 1296, 1920 x 1080, 1280 x 720			
	Sub Stream	1280 x 720 (default), 704 x 480, 704 x 576, 640 x 480, 352 x 240, 352 x 288			
	Third Stream	704 x 480 (default), 704 x 576, 480 x 240, 352 x 240, 352 x 288			
Frame Rate		Max. 30 fps (60 Hz) at 2560 x 1440, 2304 x 1296, 1920 x 1080, 1280 x 720, 704 x 480, 640 x 480, 480 x 240, 352 x 240			
		Max. 25 fps (50 Hz) at 2560 x 1440, 2304 x 1296, 1920 x 1080, 1280 x 720, 704 x 576, 640 x 480, 480 x 240, 352 x 288			
		* The frame rate and performance may vary depending on the number of connections and data bitrates (different scenes).			

Maximum Throughput	36 Mbps		
Maximum Streams * When the total bitrate is within the maximum throughput	6		
Video Analytics	Motion Detection, Object Abandoned / Missing Detection, Video Exception		
Smart Alarm	Motion Detection, SD Card Error, SD Card Full, IP Address Conflict, Cable Disconnection, Scene Change Detection, Video Blur Detection, Abnormal Color Detection		
Image Setting	Brightness, Contrast, Hue, Saturation, Sharpness, 3D Noise Reduction, BLC, Antiflicker, White Balance, Shutter, Gain, Image Orientation (Flip, Mirror, 0°, 90°, 180°, 270° – including Corridor format)		
Audio Compression	G.711		
Audio Support	One-way audio		
Deep Learning Function			
AI Analytics	Line Crossing, Region Intrusion (Human & Vehicle classification) * The two functions can only be enabled one at a time.		
Network			
Interface	10/100 Ethernet		
Protocol	802.1X authentication (EAP-TLS, EAP-MD5), DDNS, DHCP, FTP, HTTP POST, HTTP, HTTPS, IPv4, IPv6, NTP, ONVIF (Profile G, S, T, M), PPPoE, QoS, RTCP, RTMP, RTP, RTSP, SMTP, SNMP, UDP, UPnP		
Mechanical			
Camera Angle Adjustment	Pan	0 ~ 360°	
	Tilt	0 ~ 80°	
	Rotate	0 ~ 360°	
Connectors	Power	DC jack	
	Ethernet	Ethernet	RJ-45 connector
		Audio	Built-in microphone
	External microphone required		Yes (audio jack, 3.5 mm or 0.14 in)
	Built-in speaker		No
	External speaker required		No
			* Choose either the built-in or external microphone.
			* The Audio In port only supports microphones with a power supply.
Local Storage	microSD card slot (SD / SDHC / SDXC), up to 256 GB		
General			
Operating Temperature	-30°C ~ 60°C (-22°F ~ 140°F)		
Humidity	0 ~ 95% (no condensation)		
Power Source	DC 12V, 1A / PoE (IEEE 802.3af)		
Max. Power Consumption	6 W		
Dimensions	165.7 × 69 × 69 mm (6.5 × 2.7 × 2.7 in)		
Weight	0.39 kg (0.86 lb)		
Ingress Protection	IP67		
Vandal Resistance	IK10 for metal casing		
Certification	CE, FCC, RoHS, UKCA compliant		
Web Interface			
Installation Management	Web-based configuration		
Maintenance	Firmware upgrade through Web Browser or Utility		
Access from Web Browser	Live View, Playback, Video Recording, Image Quality, Bandwidth Control, Image Snapshot, Digital Zoom, Text Overlay, Image Masking, Intelligent Mark		
Language	Chinese Traditional, Czech, Dutch, English, French, German, Greek, Hebrew, Hungarian, Italian, Japanese, Korean, Norwegian, Polish, Portuguese, Romanian, Russian, Spanish, Spanish (Latin America), Turkish, Ukrainian		
Software Applications			
Software Supported	GV-VMS (V17.4.8 / V18.3.5 or later, patch files required / V20.0.0 or later), GV-Control Center (V4.2.1 or later, patch files required), GV-Edge Recording Manager (V2.3.0 or later), GV-Recording Server (V2.1.1 or later, patch files required), GV-IP Device Utility (V9.0.4 or later)		
Smart Device Access	GV-Eye for iOS and Android (V3.4.1 or later)		
Live Viewing	Web Browser (Chrome, Edge, Firefox, Safari), Mobile App		

Note: All specifications are subject to change without notice.

Packing List

1. GV-GBLF4802 Bullet Camera
2. Waterproof Rubber Set
3. Screw Kit
4. Drill Template Paster
5. Download Guide



Accessories

Model No.	Name		Details
GV-Mount211-9 (must be used with GV-Mount507-1)	Wall Mount Bracket		Dimensions: \varnothing 121 x 148 mm (\varnothing 4.76 x 5.83 in) Weight: 0.35 kg (0.77 lb)
GV-Mount314 (must be used with GV-Mount211-9 + GV-Mount507-1, GV-Mount506-1, or GV-Mount507-1)	Corner Mount Bracket		Dimensions: 215 x 121.4 x 215 mm (8.46 x 4.78 x 8.46 in) Weight: 2.05 kg (4.52 lb)
GV-Mount470 (must be used with GV-Mount211-9 + GV-Mount507-1, GV-Mount506-1, or GV-Mount507-1)	Pole Mount Bracket		Dimensions: 163.3 x 54.5 x 215 mm (6.43 x 2.15 x 8.46 in) Weight: 1.10 kg (2.43 lb)
GV-Mount506-1	Junction Box		Dimensions: 117.9 x 143.3 x 47 mm (4.64 x 5.64 x 1.85 in) Weight: 0.38 kg (0.84 lb)
GV-Mount507	Junction Box		Dimensions: \varnothing 96 x 38.8 mm (\varnothing 3.78 x 1.53 in) Weight: 0.135 kg (0.30 lb)
GV-Mount507-1	Junction Box		Dimensions: \varnothing 111.7 x 55 mm (\varnothing 4.40 x 2.17 in) Weight: 0.33 kg (0.73 lb)
GV-PA191	PoE Adapter		GV-PA191 is a Power over Ethernet (PoE) adapter designed to provide power to the IP device through a single Ethernet cable.
GV-PA301	Gigabit PoE Adapter		GV-PA301 is a Gigabit Power over Ethernet (PoE) adapter.
GV-POE Switch			GV-POE Switch is designed to provide power along with network connection for IP devices. The GV-POE Switch is available in various models with different numbers and types of ports.
Power Adapter			Contact our sales representatives for the countries and areas supported.

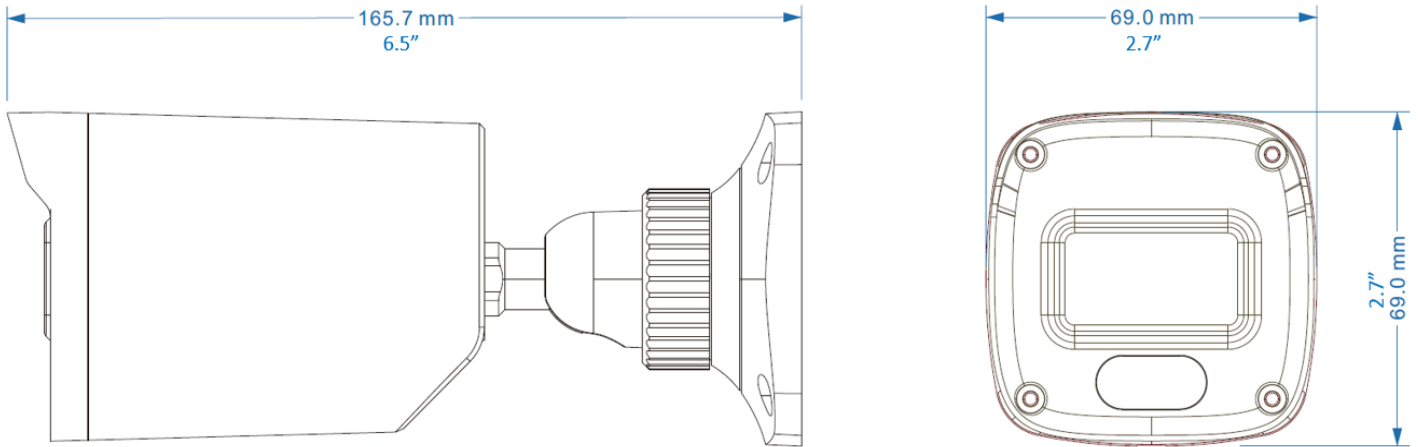
Dimensions



Mounting Type

Junction Box Mount GV-Mount506-1	Junction Box Mount GV-Mount507	Junction Box Mount GV-Mount507-1	Wall Bracket Mount GV-Mount211-9
			

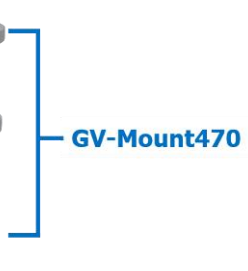
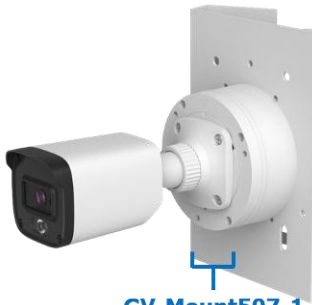
Junction Box Mount GV-Mount506-1	Pole Bracket Mount GV-Mount470	Junction Box Mount GV-Mount507-1	Pole Bracket Mount GV-Mount470
			

Junction Box Mount GV-Mount507-1	Wall Bracket Mount GV-Mount211-9	Pole Bracket Mount GV-Mount470
		

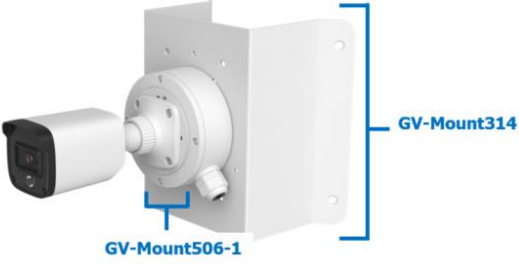
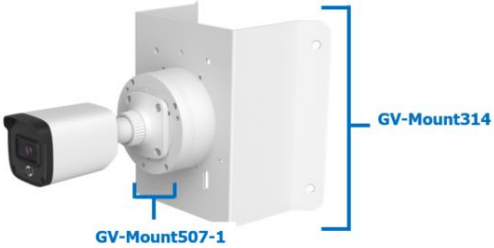
Junction Box Mount GV-Mount506-1	Corner Mount Bracket GV-Mount314	Junction Box Mount GV-Mount507-1	Corner Mount Bracket GV-Mount314
			

Junction Box Mount GV-Mount507-1	Wall Bracket Mount GV-Mount211-9	Corner Mount Bracket GV-Mount314
